

# Installation instructions

Product item NO:AC-OCTANS-5E27-BLK

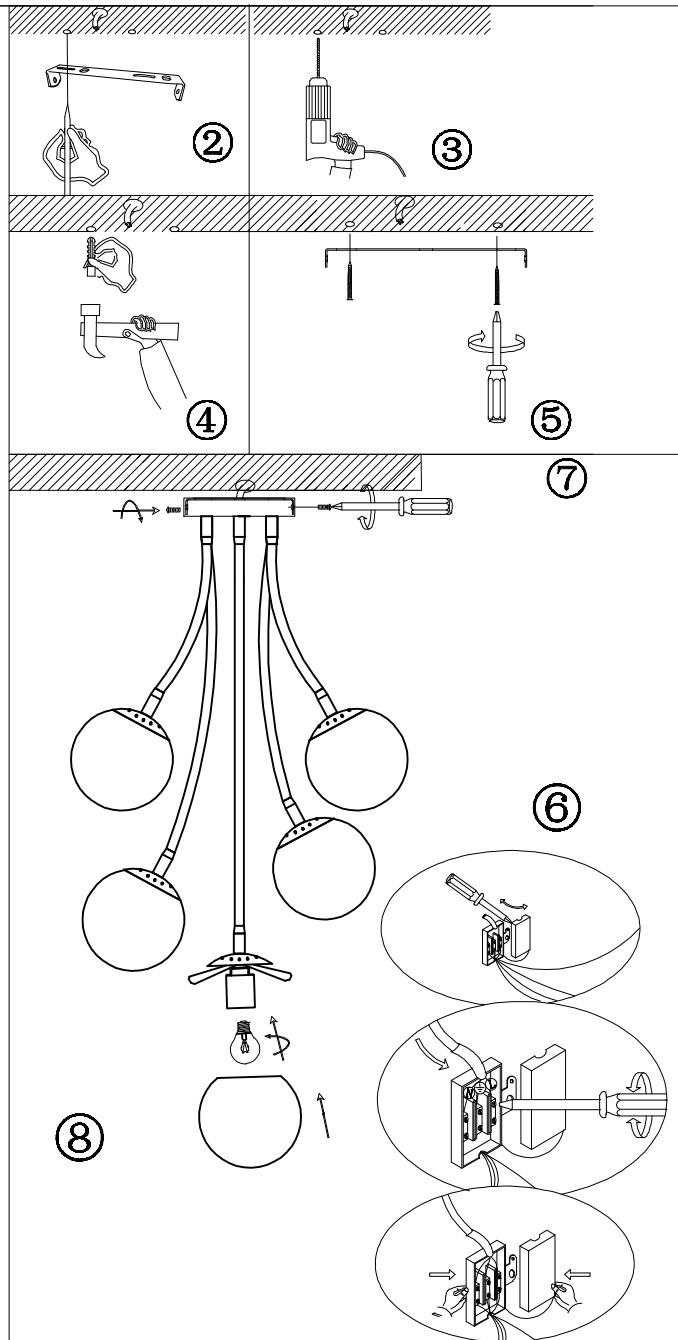
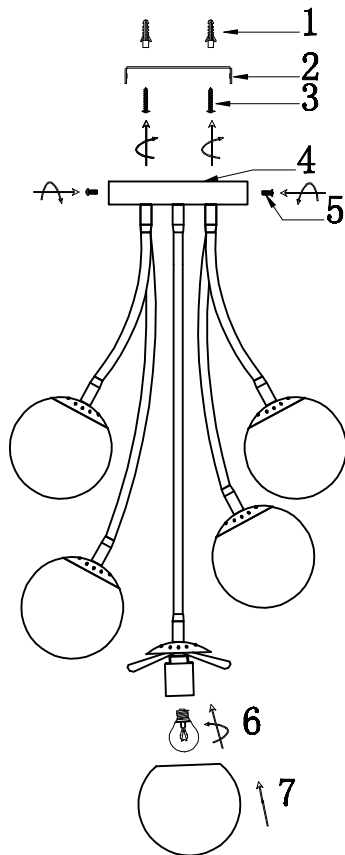

## ASSEMBLY INSTRUCTIONS

These instructions are provided for your safety.  
Please read carefully before commencing work and retain for future reference.

## SAFETY INFORMATION

- A) The supply cable runs through the inside of the fitting. Take care not to place undue stress on the cable while unpacking to prevent the possibility of a poor connection.
- B) If you are in any doubt consult a person competent to give advice on the assembly of electrical equipment.
- C) Always be sure to use the correct type and wattage of bulbs as indicated on the fitting. Never exceed the wattage stated.
- D) If the external flexible cable of the lamp is damaged, it shall be exclusively replaced by The manufacturer or his service agent or similar qualified person in order to avoid a hazard .
- E) When changing the bulb, always switch off at the mains and allow the old bulb to cool Down before handling . Dispose of used bulbs carefully.
- F) For Indoor use only